



Price List: Spare Parts N4+

Electrical Parts

Art. No.	Description	Specifications	Picture	Weight	Customs Tariff No.	C/O*	SL*	WL.*	SNo.*	Stock*	WPC*	POH*	PU*	Sales price in \$
1783	Cable set CUC 1	consisting of: – X-, Y-, Z- and A-axis cable – control unit connector with 28 pins		0.420 lb	85444290	DE	S			1		-	1 PCS	524.00
30481	Cable set CUC 2 (IO / LED)	consisting of: – 2 x LED board with cable – flow sensor cable – control unit connector with 24 pins		0.309 lb	84799070	DE	S			-		-	1 PCS	394.00
30480	Connection cable measuring key	including mounting material		0.088 lb	84799070	DE	S			-		-	1 PCS	27.00
30505	Control unit N4+	with pre-installed INI file – including mounting material		3.968 lb	85439000	DE	S		X	1		-	1 PCS	6,460.00

* PU = packing unit | C/O = country of origin | SL = service level (U=user, S=service | WL = warranty limitation | SNo. = serial number required | Stock = stock recommendation

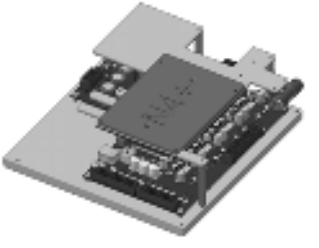
* WPC = wear parts and consumables | POH = parts on hand (recommended minimum quantity for on site service calls)

Price List: Spare Parts N4+

Electrical Parts



Art. No.	Description	Specifications	Picture	Weight	Customs Tariff No.	C/O*	SL*	WL.*	SNo.*	Stock*	WPC*	POH*	PU*	Sales price in \$
1547	End switch	including roller lever and cable		0.035 lb	84799070	CZ	S			1		-	1 PCS	48.00
2010	Ethernet cable	length approx. 2.0 m		0.174 lb	85444210	CN	U			1		-	1 PCS	12.30
30288	Ethernet socket	including mounting material		0.057 lb	84799070	GB	S			-		-	1 PCS	41.00
30367	Flow sensor	<ul style="list-style-type: none"> - sensor without moving parts - including mounting material and hose connectors 		0.772 lb	90261021	FR	S			1		-	1 PCS	639.00

* PU = packing unit | C/O = country of origin | SL = service level (U=user, S=service | WL = warranty limitation | SNo. = serial number required | Stock = stock recommendation

* WPC = wear parts and consumables | POH = parts on hand (recommended minimum quantity for on site service calls)

Price List: Spare Parts N4+

Electrical Parts





Art. No.	Description	Specifications	Picture	Weight	Customs Tariff No.	C/O*	SL*	WL.*	SNo.*	Stock*	WPC*	POH*	PU*	Sales price in \$
1832	Glass fuse T6.3A L250V	PU 10 pieces		0.002 lb	84799070	DE	U			-		-	1 PU	9.60
30181	Glass fuse T8.0A L250V	PU 10 pieces		0.035 lb	84799070	DE	S			1		1	1 PU	20.20
30482	Interlock switch with cable			0.408 lb	84799070	DE	S			-		-	1 PCS	473.00
30344	LED working chamber lighting	<ul style="list-style-type: none"> – LED for one machine side (suitable for left and right side) – including light diffuser, gasket and mounting material 		0.037 lb	84799070	DE	S			2		2	1 PCS	89.00

* PU = packing unit | C/O = country of origin | SL = service level (U=user, S=service | WL = warranty limitation | SNo. = serial number required | Stock = stock recommendation

* WPC = wear parts and consumables | POH = parts on hand (recommended minimum quantity for on site service calls)

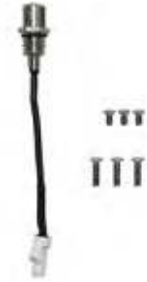
Price List: Spare Parts N4+

Electrical Parts

Art. No.	Description	Specifications	Picture	Weight	Customs Tariff No.	C/O*	SL*	WL.*	SNo.*	Stock*	WPC*	POH*	PU*	Sales price in \$
30450	Measuring key	including mounting material		0.033 lb	85365019	JP	S			1		-	1 PCS	582.00
1798	Power supply cord B	<ul style="list-style-type: none"> - connector plug up to 120 V - plug type B - length approx. 1.8 m - UL certified - ferrite core as EMC filter 		0.400 lb	85444290	DE	U			1		-	1 PCS	26.00
30479	Spindle cable			0.309 lb	84799070	DE	S			1		-	1 PCS	336.00
30555	Switching mode power supply	May only be replaced by a qualified electrician. After repair work the machine requires a test of the electrical safety according to VDE.		2.392 lb	84799070	DE	S			1		-	1 PCS	473.00

* PU = packing unit | C/O = country of origin | SL = service level (U=user, S=service | WL = warranty limitation | SNo. = serial number required | Stock = stock recommendation

* WPC = wear parts and consumables | POH = parts on hand (recommended minimum quantity for on site service calls)

Price List: Spare Parts N4+

Electrical Parts





Art. No.	Description	Specifications	Picture	Weight	Customs Tariff No.	C/O*	SL*	WL.*	SNo.*	Stock*	WPC*	POH*	PU*	Sales price in \$
30483	Webcam	including mounting material and protective cap		0.121 lb	84799070	DE	S			-		-	1 PCS	425.00

* PU = packing unit | C/O = country of origin | SL = service level (U=user, S=service | WL = warranty limitation | SNo. = serial number required | Stock = stock recommendation

* WPC = wear parts and consumables | POH = parts on hand (recommended minimum quantity for on site service calls)

Price List: Spare Parts N4+

Housings and Accessories



Art. No.	Description	Specifications	Picture	Weight	Customs Tariff No.	C/O*	SL*	WL.*	SNo.*	Stock*	WPC*	POH*	PU*	Sales price in \$
30484	Cover cooling liquid drawer, type vhf	<ul style="list-style-type: none"> – including mounting material – in signal white (RAL 9003) – with labeling "vhf" 		1.587 lb	84799070	DE	S			-		-	1 PCS	462.00
2053	Drawer slides	2 pieces including mounting material		0.500 lb	83024900		S			-		-	1 SET	95.00
30334	Gas spring 40 N	<ul style="list-style-type: none"> – for working chamber door – including mounting material <i>for use in machines where the serial number begins with N4ID2 or N4PD</i> 		0.075 lb	83024900	DE	S			1		-	1 PCS	64.00
1651	Hinged actuator for door locking switch			0.022 lb	84799070	JP	S			1		-	1 PCS	15.80

* PU = packing unit | C/O = country of origin | SL = service level (U=user, S=service | WL = warranty limitation | SNo. = serial number required | Stock = stock recommendation

* WPC = wear parts and consumables | POH = parts on hand (recommended minimum quantity for on site service calls)

Price List: Spare Parts N4+

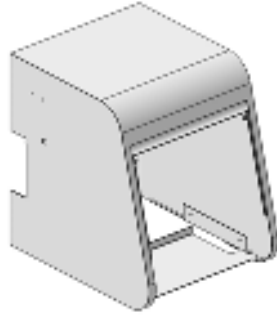
Housings and Accessories





Art. No.	Description	Specifications	Picture	Weight	Customs Tariff No.	C/O*	SL*	WL.*	SNo.*	Stock*	WPC*	POH*	PU*	Sales price in \$
30486	Housing cover N4+	metal housing cover coloured in signal white (RAL 9003) – including housing screws – without identification label		18.519 lb	84799070	DE	S			-		-	1 PCS	1,610.00
30485	Working chamber door, type vhf	– including mounting material – in signal white (RAL 9003) – with labeling "vhf"		4.740 lb	84799070	DE	S			-		-	1 PCS	1,200.00

* PU = packing unit | C/O = country of origin | SL = service level (U=user, S=service | WL = warranty limitation | SNo. = serial number required | Stock = stock recommendation

* WPC = wear parts and consumables | POH = parts on hand (recommended minimum quantity for on site service calls)

Price List: Spare Parts N4+

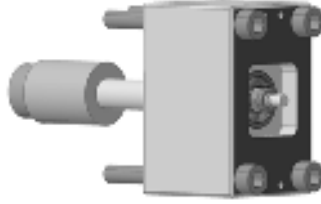
Mechanical Parts



Art. No.	Description	Specifications	Picture	Weight	Customs Tariff No.	C/O*	SL*	WL.*	SNo.*	Stock*	WPC*	POH*	PU*	Sales price in \$
1780	A-axis drive	consisting of: – bull gear – pinion – axis motor including joint & axis motor cable – mounting material		0.463 lb	84799070	DE	S			-		-	1 PCS	786.00
2033	Ball screw drive X-axis/Y-axis	Mount to – X-axis with cylinder screw M6x50 – Y-axis with cylinder screw M6x55		0.653 lb	84799070	DE	S	X		-		-	1 PCS	1,230.00
30335	Ball screw drive Z-axis	including mounting material		0.992 lb	84799070	DE	S	X		-		-	1 PCS	1,180.00
1661	Bellows coupling	including screws		0.022 lb	84799070	DE	S			1		-	1 PCS	67.00

* PU = packing unit | C/O = country of origin | SL = service level (U=user, S=service | WL = warranty limitation | SNo. = serial number required | Stock = stock recommendation

* WPC = wear parts and consumables | POH = parts on hand (recommended minimum quantity for on site service calls)

Price List: Spare Parts N4+

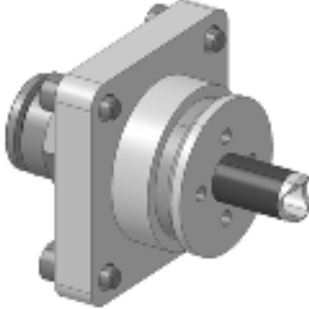
Mechanical Parts

Art. No.	Description	Specifications	Picture	Weight	Customs Tariff No.	C/O*	SL*	WL.*	SNo.*	Stock*	WPC*	POH*	PU*	Sales price in \$
1943	Cooling liquid pump	including mounting material and hose connectors <i>R5: can be used for machines with serial numbers $\geq R5ID6$ and retrofitted machines with serial numbers $\leq R5ID5$</i>		2.180 lb	84799070	DE	S			1	X	1	1 PCS	798.00
30489	Coupler plug			0.143 lb	84799070	DE	S			1	X	1	1 PCS	134.00
1947	Coupling of the cooling liquid tank	including gasket		0.050 lb	84799070	DE	U			1	X	1	1 PCS	98.00
1781	Fixation unit A-axis	including mounting material		0.181 lb	84799070	DE	S			-		-	1 PCS	324.00

* PU = packing unit | C/O = country of origin | SL = service level (U=user, S=service | WL = warranty limitation | SNo. = serial number required | Stock = stock recommendation

* WPC = wear parts and consumables | POH = parts on hand (recommended minimum quantity for on site service calls)

Price List: Spare Parts N4+

Mechanical Parts

Art. No.	Description	Specifications	Picture	Weight	Customs Tariff No.	C/O*	SL*	WL.*	SNo.*	Stock*	WPC*	POH*	PU*	Sales price in \$
1570	Fixing insert for tool changer	<ul style="list-style-type: none"> – rubber inserts for tool changer – PU 2 pieces 		0.050 lb	84799070	DE	U			5	X	1	1 PU	20.50
30488	Folding bellows	including mounting material		0.595 lb	84799070	DE	S			1		-	1 PCS	523.00
30487	Nozzle plate	including mounting material		0.882 lb	84799070	DE	S			1		-	1 PCS	177.00
1791	Rubber-metal buffer	<ul style="list-style-type: none"> – for the fixation unit A-axis – including mounting material 		0.033 lb	40169991	DE	S			1	X	1	1 PCS	9.90

* PU = packing unit | C/O = country of origin | SL = service level (U=user, S=service | WL = warranty limitation | SNo. = serial number required | Stock = stock recommendation

* WPC = wear parts and consumables | POH = parts on hand (recommended minimum quantity for on site service calls)

Price List: Spare Parts N4+

Mechanical Parts

Art. No.	Description	Specifications	Picture	Weight	Customs Tariff No.	C/O*	SL*	WL.*	SNo.*	Stock*	WPC*	POH*	PU*	Sales price in \$
1789	Spring plunger	with hexagon socket and ball		0.031 lb	73181900	DE	S			1		-	1 PCS	17.00
1592	Stepping motor			0.850 lb	85011091	CN	S			1		-	1 PCS	206.00
30490	Tool magazine			0.331 lb	84799070	DE	U			1		-	1 PCS	215.00
30491	Tool magazine holder	including measuring key and mounting material		1.202 lb	84799070	DE	S			-		-	1 PCS	919.00

* PU = packing unit | C/O = country of origin | SL = service level (U=user, S=service | WL = warranty limitation | SNo. = serial number required | Stock = stock recommendation

* WPC = wear parts and consumables | POH = parts on hand (recommended minimum quantity for on site service calls)

Price List: Spare Parts N4+

Mechanical Parts

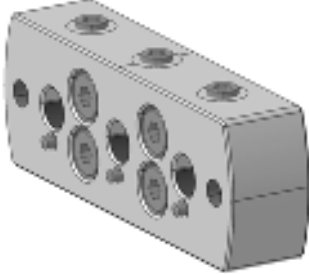

Art. No.	Description	Specifications	Picture	Weight	Customs Tariff No.	C/O*	SL*	WL.*	SNo.*	Stock*	WPC*	POH*	PU*	Sales price in \$
1739	Workpiece holder	<ul style="list-style-type: none"> - including mounting material - including torque wrench 1.8 Nm and insert bit 		0.140 lb	84799070	DE	S			-		-	1 PCS	172.00

* PU = packing unit | C/O = country of origin | SL = service level (U=user, S=service | WL = warranty limitation | SNo. = serial number required | Stock = stock recommendation

* WPC = wear parts and consumables | POH = parts on hand (recommended minimum quantity for on site service calls)

Price List: Spare Parts N4+

Pneumatical Parts

Art. No.	Description	Specifications	Picture	Weight	Customs Tariff No.	C/O*	SL*	WL.*	SNo.*	Stock*	WPC*	POH*	PU*	Sales price in \$
1686	Bulkhead fitting	<ul style="list-style-type: none"> – for 6 mm pneumatic hose – max. 10 bar 		0.050 lb	84799070	DE	S			-		-	1 PCS	9.50
1825	Filter element for service unit MICRO	date of manufacture of the machine from 04/2014		0.004 lb	84219990	HU	U			5	X	2	1 PCS	9.00
1922	Plastic hose 4 mm	<ul style="list-style-type: none"> – UL-94-certified – PU 3 m 		1.587 ozm	84799070	CZ	S			-		-	1 PU	15.20
1664	Plastic hose 6 mm	<ul style="list-style-type: none"> – UL-94-certified – 10 bar max. – PU 3 m 		0.015 lb	39173200	DE	U			1		-	1 PU	15.20

* PU = packing unit | C/O = country of origin | SL = service level (U=user, S=service | WL = warranty limitation | SNo. = serial number required | Stock = stock recommendation

* WPC = wear parts and consumables | POH = parts on hand (recommended minimum quantity for on site service calls)

Price List: Spare Parts N4+

Pneumatical Parts



Art. No.	Description	Specifications	Picture	Weight	Customs Tariff No.	C/O*	SL*	WL.*	SNo.*	Stock*	WPC*	POH*	PU*	Sales price in \$
1675	Plug connection USA			0.044 lb	84799070	DE	S			-		-	1 PCS	9.90
1666	Service unit MICRO	with water separator, manometer and pressure regulator		0.500 lb	84811005	DE	U			1		-	1 PCS	159.00
1499	Solenoid valve MHP1-UL	for mounting at valve terminal, including – 2 screws – hose connector and plug-in connection wire – for UL certified machines – installed in S models since November 2013		0.816 lb	84812090	DE	S			1		-	1 PCS	74.00

* PU = packing unit | C/O = country of origin | SL = service level (U=user, S=service | WL = warranty limitation | SNo. = serial number required | Stock = stock recommendation

* WPC = wear parts and consumables | POH = parts on hand (recommended minimum quantity for on site service calls)

Price List: Spare Parts N4+

Miscellaneous

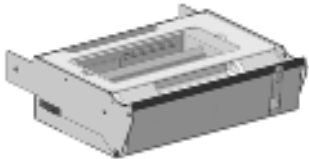



Art. No.	Description	Specifications	Picture	Weight	Customs Tariff No.	C/O*	SL*	WL.*	SNo.*	Stock*	WPC*	POH*	PU*	Sales price in \$
30500	Accessory case N4+	<ul style="list-style-type: none"> – complete machine accessories – without instruction manuals 		7.606 lb	84799070	DE	U			-		-	1 PCS	767.00
1785	Calibration blank	<ul style="list-style-type: none"> – without retaining bolt and screws – PU 5 pieces 		0.500 lb	84799070	DE	U			2	X	1	1 PU	49.00
30494	Clamping spring cooling liquid tank	including mounting material		0.033 lb	84799070	DE	S			1		-	1 PCS	22.20
30495	Cooling liquid drawer			8.664 lb	84799070	DE	S			-		-	1 PCS	1,250.00

* PU = packing unit | C/O = country of origin | SL = service level (U=user, S=service | WL = warranty limitation | SNo. = serial number required | Stock = stock recommendation

* WPC = wear parts and consumables | POH = parts on hand (recommended minimum quantity for on site service calls)

Price List: Spare Parts N4+

Miscellaneous



Art. No.	Description	Specifications	Picture	Weight	Customs Tariff No.	C/O*	SL*	WL.*	SNo.*	Stock*	WPC*	POH*	PU*	Sales price in \$
30492	Cover cooling liquid tank	without strainer basket		0.706 lb	84799070	DE	U			-		-	1 PCS	172.00
30308	Filter for cooling liquid tank	for installation in the cooling liquid filter – including fine filter and activated carbon pellets		0.176 lb	84799070	DE	U			1		1	1 PCS	195.00
30309	Filter set	consisting of – 3 pcs. of fine filter – 6 g of activated carbon pellets		0.500 lb	84212100	DE	U			5	X	1	1 SET	23.70
1850	Fin Food Lube	– for linear guiding – PU 250 ml <i>safety data sheet: http://download.vhf.de</i>		0.500 lb	27101999	NL	S			1	X	1	1 PCS	64.00

* PU = packing unit | C/O = country of origin | SL = service level (U=user, S=service | WL = warranty limitation | SNo. = serial number required | Stock = stock recommendation

* WPC = wear parts and consumables | POH = parts on hand (recommended minimum quantity for on site service calls)

Price List: Spare Parts N4+

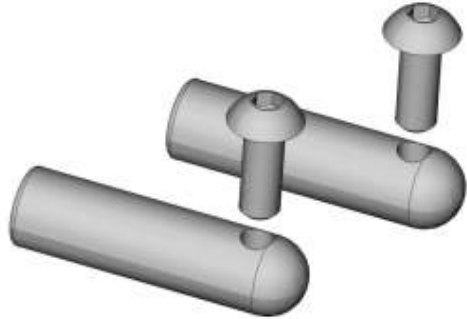
Miscellaneous

Art. No.	Description	Specifications	Picture	Weight	Customs Tariff No.	C/O*	SL*	WL.*	SNo.*	Stock*	WPC*	POH*	PU*	Sales price in \$
1786	Fixation calibration blank	Set, consisting of 2 pins and 2 screws – for fixation of the calibration blank at the workpiece holder – PU 2 pieces		0.500 lb	84799070	DE	U			5	X	3	1 PU	32.00
30380	Gasket working chamber door	– to be mounted at the backside of the door <i>for machines with serial numbers that start with N4PD3 or N4PD4</i>		0.033 lb	84799070	DE	U			1	X	1	1 PCS	52.00
1923	Grub screw M5x10 A2	PU 3 pieces		0.044 lb	73181535	DE	U			1	X	1	1 PU	5.30
1830	Interdental brush 0.45 mm orange	– including protective cap – PU 5 pieces		0.020 lb	84799070	DE	U			1		-	1 PU	11.10

* PU = packing unit | C/O = country of origin | SL = service level (U=user, S=service | WL = warranty limitation | SNo. = serial number required | Stock = stock recommendation

* WPC = wear parts and consumables | POH = parts on hand (recommended minimum quantity for on site service calls)

Price List: Spare Parts N4+

Miscellaneous



Art. No.	Description	Specifications	Picture	Weight	Customs Tariff No.	C/O*	SL*	WL.*	SNo.*	Stock*	WPC*	POH*	PU*	Sales price in \$
1635	Measuring cup, 500 ml			0.123 lb	84799070	DE	U			2		-	1 PCS	10.40
1633	pH testing strips	PU with 100 strips		0.020 lb	84799070	DE	U			1	X	1	1 PU	50.00
30496	Protection bracket Z-axis	including mounting material		8.664 lb	84799070	DE	S			-		-	1 PCS	32.00
30497	Protective cap for the webcam			0.011 lb	84799070	DE	U			1		-	1 PCS	39.00

* PU = packing unit | C/O = country of origin | SL = service level (U=user, S=service | WL = warranty limitation | SNo. = serial number required | Stock = stock recommendation

* WPC = wear parts and consumables | POH = parts on hand (recommended minimum quantity for on site service calls)

Price List: Spare Parts N4+

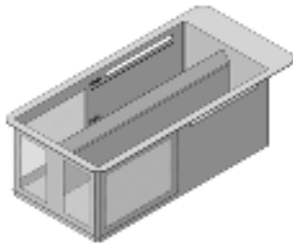
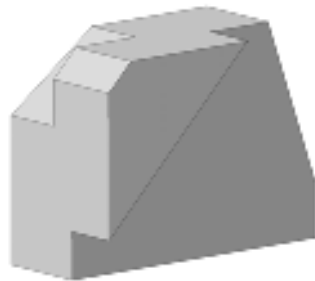
Miscellaneous

Art. No.	Description	Specifications	Picture	Weight	Customs Tariff No.	C/O*	SL*	WL.*	SNo.*	Stock*	WPC*	POH*	PU*	Sales price in \$
30493	Sealing lip cooling liquid drawer			0.055 lb	84799070	DE	S			1		1	1 PCS	23.00
30498	Strainer basket			1.069 lb	84799070	DE	U			-		-	1 PCS	368.00
2021	Transport lock N4/N4+	for spindle SFN 300P and SFN+ 400P		0.121 lb	39239000	DE	U			1		-	1 PCS	12.30
1865	White Grease	– for ball screw spindles – tube 150 ml <i>safety data sheet: http://download.vhf.de</i>		0.500 lb	27101999	NL	U			1	X	-	1 PCS	63.00

* PU = packing unit | C/O = country of origin | SL = service level (U=user, S=service | WL = warranty limitation | SNo. = serial number required | Stock = stock recommendation

* WPC = wear parts and consumables | POH = parts on hand (recommended minimum quantity for on site service calls)

Price List: Spare Parts N4+

Spindles and Accessories

Art. No.	Description	Specifications	Picture	Weight	Customs Tariff No.	C/O*	SL*	WL.*	SNo.*	Stock*	WPC*	POH*	PU*	Sales price in \$
30045	Collet chuck 3 mm, stainless	with ceramic coating		0.050 lb	84661020	DE	U			2	X	1	1 PCS	238.00
30501	High frequency spindle SFN+ 400P	– high frequency spindle rotational speed 5,000 to 80,000 RPM maximum power output 800 W continuous power 440 W 4-fold bearing hybrid ceramic ball bearings stainless steel collet chuck including service set <i>version with sealing air and cone cleaning including pneumatical collet chuck</i>		2.425 lb	84799070	DE	S		X	1		1	1 PCS	5,520.00
1730	Spindle service set	for collet chuck maintenance		0.132 lb	96039099	DE	U			1	X	1	1 PCS	57.00

* PU = packing unit | C/O = country of origin | SL = service level (U=user, S=service | WL = warranty limitation | SNo. = serial number required | Stock = stock recommendation

* WPC = wear parts and consumables | POH = parts on hand (recommended minimum quantity for on site service calls)

Price List: Spare Parts N4+

Tools





Art. No.	Description	Specifications	Picture	Weight	Customs Tariff No.	C/O*	SL*	WL.*	SNo.*	Stock*	WPC*	POH*	PU*	Sales price in \$
1512	Dial indicator with stand	<ul style="list-style-type: none"> - with 3D articulated arm and clamp stand - for true running and axis backlash measurements - measuring accuracy ± 0.01 mm 		2.000 lb	84799070	JP	S			-		1	1 PCS	639.00
1841	Digital measuring slide	measuring range 100 mm		0.450 lb	84799070	CN	U			-		-	1 PCS	103.00
1655	Digital micrometer screw gauge	0–25 mm		1.000 lb	84799070	CN	U			1		-	1 PCS	180.00
1731	Drill with 3 mm shank	<ul style="list-style-type: none"> Ø cutting edge 2.80 mm, Ø shank 3.0 mm L cutting edge 10.5 mm, L total 38 mm with stop ring 		0.070 lb	82075090	DE	U			2	X	1	1 PCS	7.40

* PU = packing unit | C/O = country of origin | SL = service level (U=user, S=service | WL = warranty limitation | SNo. = serial number required | Stock = stock recommendation

* WPC = wear parts and consumables | POH = parts on hand (recommended minimum quantity for on site service calls)

Price List: Spare Parts N4+

Tools





Art. No.	Description	Specifications	Picture	Weight	Customs Tariff No.	C/O*	SL*	WL.*	SNo.*	Stock*	WPC*	POH*	PU*	Sales price in \$
1770	Insert bit 2,0x50 mm			0.015 lb	82042000	DE	U			-		-	1 PCS	8.00
2040	Insert bit 2.5x25 mm			0.018 lb	82042000	DE	U			-		-	1 PCS	8.00
1778	Insert bit 2.5x89 mm			0.026 lb	82042000	DE	S			1		1	1 PCS	15.80
2022	Insert bit 3.0x25 mm			0.018 lb	82041100	DE	U			-		-	1 PCS	8.00

* PU = packing unit | C/O = country of origin | SL = service level (U=user, S=service | WL = warranty limitation | SNo. = serial number required | Stock = stock recommendation

* WPC = wear parts and consumables | POH = parts on hand (recommended minimum quantity for on site service calls)

Price List: Spare Parts N4+

Tools



Art. No.	Description	Specifications	Picture	Weight	Customs Tariff No.	C/O*	SL*	WL.*	SNo.*	Stock*	WPC*	POH*	PU*	Sales price in \$
30078	Insert bit TX 10x35 mm			0.018 lb	82042000	DE	U			1		1	1 PCS	10.60
1654	Measuring pin	for automatic measuring		0.009 lb	82075090	DE	U			10	X	2	1 PCS	8.20
1824	Service trolley case	<ul style="list-style-type: none"> – robust trolley case for service works – precise measuring equipment and high-quality tools – complete kit for all vhf Impression machines 		33.100 lb	82059090	DE	S			-		1	1 PCS	3,930.00
1779	Torque wrench 1.5 Nm	without insert bit		0.150 lb	82041100	TW	S			-		-	1 PCS	24.60

* PU = packing unit | C/O = country of origin | SL = service level (U=user, S=service | WL = warranty limitation | SNo. = serial number required | Stock = stock recommendation

* WPC = wear parts and consumables | POH = parts on hand (recommended minimum quantity for on site service calls)

Price List: Spare Parts N4+

Tools

Art. No.	Description	Specifications	Picture	Weight	Customs Tariff No.	C/O*	SL*	WL.*	SNo.*	Stock*	WPC*	POH*	PU*	Sales price in \$
1769	Torque wrench 1.8 Nm	without insert bit		0.143 lb	82041100	TW	U			-		-	1 PCS	24.60
1954	Unlocking tool	<ul style="list-style-type: none"> - for door locking switch - PU 2 pieces 		0.000 lb	39269097	DE	U			1		1	1 PU	8.20

Please note that single articles can be used in several machine models. Our stock recommendation is intended for 1 to 20 machines per service base. We grant the standard discount for spare parts.

Warranty limitation: warranty claims can only be made if the relevant machine is inspected and repaired by vhf. Alternatively, the partner can order the part within the warranty period and exchange it at his/her own expense and liability.

Prices are list prices and do not include any discounts, tax, shipping or other charges that may apply • All purchases are subject to our Terms of Sale which can be found at www.vhf.com • Products, prices and terms are subject to change without notice • All product names, brands and trademarks are property of their respective owners • All prices exclude VAT, customs duties and transportation/packaging fees • All information given may change without further notice.