

Price List: Spare Parts K5+

Electrical Parts

Art. No.	Description	Specifications	Picture	Weight	Customs Tariff No.	C/O*	SL*	WL.*	SNo.*	Stock*	WPC*	POH*	PU*	Sales price in \$
1891	Axis cable set (X, Y, Z, B)	consisting of: – axis cables (X, Y, Z, B) – control unit connector CUC 1 with 40 pins		0.950 lb	84799070	DE	S			1		-	1 PCS	603.00
2052	Data cable Renfert SILENT CAM	– plug with 6 pins – length 5 m		0.364 lb	85087000	DE	U			-		-	1 PCS	74.00
1884	End switch	including mounting material		0.049 lb	84818079	CZ	S			2		-	1 PCS	48.00
2010	Ethernet cable	length approx. 2.0 m		0.174 lb	85444210	CN	U			1		-	1 PCS	12.30

* PU = packing unit | C/O = country of origin | SL = service level (U=user, S=service | WL = warranty limitation | SNo. = serial number required | Stock = stock recommendation

* WPC = wear parts and consumables | POH = parts on hand (recommended minimum quantity for on site service calls)

Price List: Spare Parts K5+

Electrical Parts

Art. No.	Description	Specifications	Picture	Weight	Customs Tariff No.	C/O*	SL*	WL.*	SNo.*	Stock*	WPC*	POH*	PU*	Sales price in \$
30288	Ethernet socket	including mounting material		0.057 lb	84799070	GB	S			-		-	1 PCS	41.00
1832	Glass fuse T6.3A L250V	PU 10 pieces		0.002 lb	84799070	DE	U			-		-	1 PU	9.60
30181	Glass fuse T8.0A L250V	PU 10 pieces		0.035 lb	84799070	DE	S			1		1	1 PU	20.20
1890	Interlock switch/LED boards with cable set	consisting of: - interlock switch - LED boards with cable - control unit connector CUC 2 with 28 pins		0.600 lb	84799070	DE	S			1		-	1 PCS	495.00

* PU = packing unit | C/O = country of origin | SL = service level (U=user, S=service | WL = warranty limitation | SNo. = serial number required | Stock = stock recommendation

* WPC = wear parts and consumables | POH = parts on hand (recommended minimum quantity for on site service calls)

Price List: Spare Parts K5+

Electrical Parts

Art. No.	Description	Specifications	Picture	Weight	Customs Tariff No.	C/O*	SL*	WL.*	SNo.*	Stock*	WPC*	POH*	PU*	Sales price in \$
30117	Ion jet left	including DC voltage converter and mounting material		0.500 lb	84799070	DE	S			-		-	1 PCS	439.00
30118	Ion jet right	including mounting material		0.500 lb	84799070	DE	S			-		-	1 PCS	439.00
1903	Measuring key	including mounting material		0.150 lb	84798997	CH	S			1	X	1	1 PCS	581.00
1589	Power supply cord B	<ul style="list-style-type: none"> - connector plug up to 120 V - plug type B - length approx. 1.8 m - UL certified 		0.700 lb	85444290		U			1		-	1 PCS	14.00

* PU = packing unit | C/O = country of origin | SL = service level (U=user, S=service | WL = warranty limitation | SNo. = serial number required | Stock = stock recommendation

* WPC = wear parts and consumables | POH = parts on hand (recommended minimum quantity for on site service calls)

Price List: Spare Parts K5+

Electrical Parts

Art. No.	Description	Specifications	Picture	Weight	Customs Tariff No.	C/O*	SL*	WL.*	SNo.*	Stock*	WPC*	POH*	PU*	Sales price in \$
1892	Spindle cable			0.450 lb	84799070	DE	S			1		-	1 PCS	344.00
30555	Switching mode power supply	May only be replaced by a qualified electrician. After repair work the machine requires a test of the electrical safety according to VDE.		2.392 lb	84799070	DE	S			1		-	1 PCS	473.00
1612	USB connecting socket	without mounting material		0.100 lb	84799070	DE	S			-		-	1 PCS	30.00
30119	Webcam	including mounting material and protective cap		0.500 lb	84799070	DE	S			-		-	1 PCS	419.00

* PU = packing unit | C/O = country of origin | SL = service level (U=user, S=service | WL = warranty limitation | SNo. = serial number required | Stock = stock recommendation

* WPC = wear parts and consumables | POH = parts on hand (recommended minimum quantity for on site service calls)



**Price List: Spare Parts K5+
Housings and Accessories**

Art. No.	Description	Specifications	Picture	Weight	Customs Tariff No.	C/O*	SL*	WL.*	SNo.*	Stock*	WPC*	POH*	PU*	Sales price in \$
1889	Gas spring 70 N	PU 2 pieces		0.200 lb	84799070	DE	S			1	X	1	1 PU	151.00
1651	Hinged actuator for door locking switch			0.022 lb	84799070	JP	S			1		-	1 PCS	15.80

* PU = packing unit | C/O = country of origin | SL = service level (U=user, S=service | WL = warranty limitation | SNo. = serial number required | Stock = stock recommendation
* WPC = wear parts and consumables | POH = parts on hand (recommended minimum quantity for on site service calls)

Price List: Spare Parts K5+

Mechanical Parts

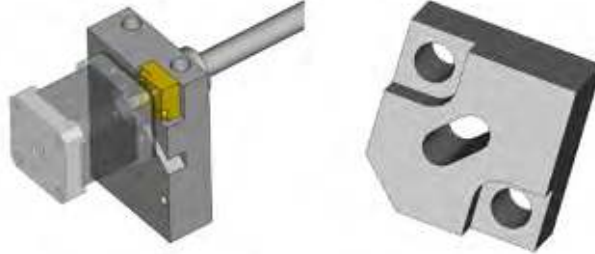
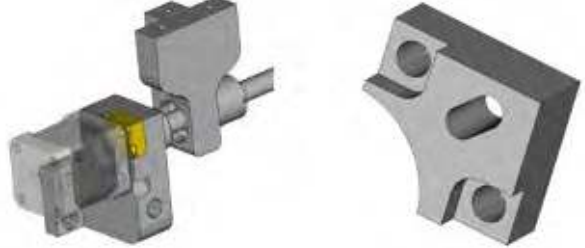
Art. No.	Description	Specifications	Picture	Weight	Customs Tariff No.	C/O*	SL*	WL.*	SNo.*	Stock*	WPC*	POH*	PU*	Sales price in \$
30477	A-axis			0.441 lb	84799070	DE	S	X		-		-	1 PCS	756.00
1881	Anti-rotation lock axis motor B-axis	including mounting material		0.050 lb	84818079	DE	S			2		-	1 PCS	57.00
1883	Anti-rotation lock axis motor X-/Z-axis	including mounting material		0.050 lb	84818079	DE	S			4		-	1 PCS	57.00
1882	Anti-rotation lock axis motor Y-axis	including mounting material		0.050 lb	84818079	DE	S			2		-	1 PCS	57.00

* PU = packing unit | C/O = country of origin | SL = service level (U=user, S=service | WL = warranty limitation | SNo. = serial number required | Stock = stock recommendation

* WPC = wear parts and consumables | POH = parts on hand (recommended minimum quantity for on site service calls)

Price List: Spare Parts K5+

Mechanical Parts

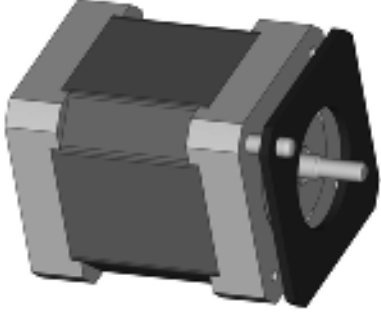
Art. No.	Description	Specifications	Picture	Weight	Customs Tariff No.	C/O*	SL*	WL.*	SNo.*	Stock*	WPC*	POH*	PU*	Sales price in \$
1880	Axis motor	consisting of: – step motor with cylinder pin – damper mat		0.850 lb	85011091	CN	S			4		-	1 PCS	229.00
2050	Ball screw drive B-axis	including mounting material		1.500 lb	84799070	FR	S	X		-		-	1 PCS	1,610.00
2047	Ball screw drive X-axis	including mounting material		0.800 lb	84799070	FR	S	X		1		-	1 PCS	1,280.00
2048	Ball screw drive Y-axis	including mounting material		1.550 lb	84799070	FR	S	X		1		-	1 PCS	1,210.00

* PU = packing unit | C/O = country of origin | SL = service level (U=user, S=service | WL = warranty limitation | SNo. = serial number required | Stock = stock recommendation

* WPC = wear parts and consumables | POH = parts on hand (recommended minimum quantity for on site service calls)

Price List: Spare Parts K5+

Mechanical Parts



Art. No.	Description	Specifications	Picture	Weight	Customs Tariff No.	C/O*	SL*	WL.*	SNo.*	Stock*	WPC*	POH*	PU*	Sales price in \$
2049	Ball screw drive Z-axis	including mounting material		0.800 lb	84799070	FR	S	X		-		-	1 PCS	1,130.00
1887	Bellows	including mounting material		0.150 lb	84799070	DE	S			1		-	1 PCS	393.00
30354	Blank holder K5+/K5	<ul style="list-style-type: none"> - for tool-less blank mounting (DirectDiscTechnology) - including mounting material 		0.000 lb	84799070	DE	S			-		-	1 PCS	2,430.00
30154	Clamp ring for ball screw drives	including clamping screw		0.033 lb	84818079	DE	S			1		4	1 PCS	17.20

* PU = packing unit | C/O = country of origin | SL = service level (U=user, S=service | WL = warranty limitation | SNo. = serial number required | Stock = stock recommendation

* WPC = wear parts and consumables | POH = parts on hand (recommended minimum quantity for on site service calls)

Price List: Spare Parts K5+

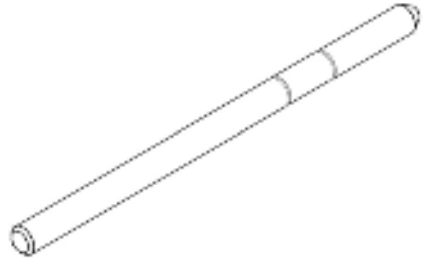
Mechanical Parts

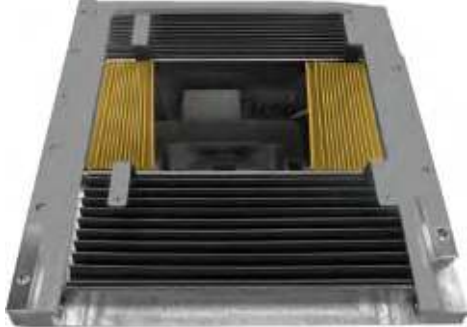
Art. No.	Description	Specifications	Picture	Weight	Customs Tariff No.	C/O*	SL*	WL.*	SNo.*	Stock*	WPC*	POH*	PU*	Sales price in \$
1970	Concentricity test pin	to adjust the concentricity of ball screw drives		0.050 lb	84799070	DE	S			-		1	1 PCS	47.00
30365	Double cone locking mechanism blank holder K5+	PU 2 pieces		0.000 lb	84799070	DE	S			-		-	1 PU	87.00
1570	Fixing insert for tool changer	- rubber inserts for tool changer - PU 2 pieces		0.050 lb	84799070	DE	U			5	X	1	1 PU	20.50
1886	Folding bellow X-axis (215 mm length)	PU 2 pieces		0.220 lb	84799070	DE	S			1		-	1 PU	213.00

* PU = packing unit | C/O = country of origin | SL = service level (U=user, S=service | WL = warranty limitation | SNo. = serial number required | Stock = stock recommendation

* WPC = wear parts and consumables | POH = parts on hand (recommended minimum quantity for on site service calls)

Price List: Spare Parts K5+

Mechanical Parts

Art. No.	Description	Specifications	Picture	Weight	Customs Tariff No.	C/O*	SL*	WL.*	SNo.*	Stock*	WPC*	POH*	PU*	Sales price in \$
1885	Folding bellow Y-axis (300 mm length)	PU 2 pieces		0.430 lb	84799070	DE	S			1		-	1 PU	295.00
1894	Front cover stop	– including mounting material – PU set of 2 pieces		0.050 lb	84799070	DE	S			1		-	1 PU	22.90
1897	Hinged actuator retainer	including mounting material		0.180 lb	84798997	DE	S			-		-	1 PCS	49.00
1900	Nozzle cover	including mounting material		0.051 lb	84798997	DE	S			-		-	1 PCS	157.00

* PU = packing unit | C/O = country of origin | SL = service level (U=user, S=service | WL = warranty limitation | SNo. = serial number required | Stock = stock recommendation

* WPC = wear parts and consumables | POH = parts on hand (recommended minimum quantity for on site service calls)

Price List: Spare Parts K5+

Mechanical Parts

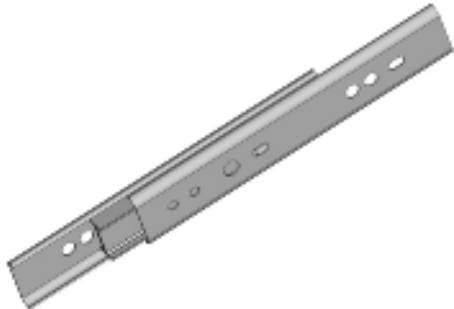
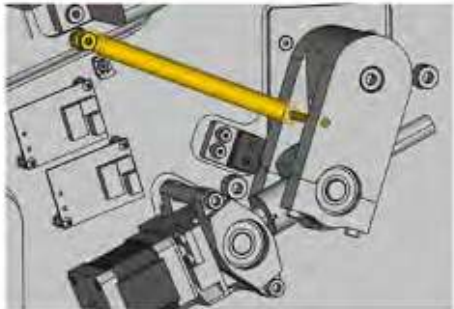
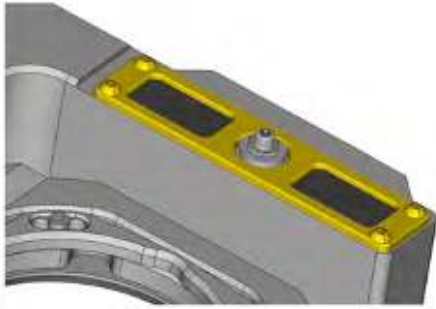

Art. No.	Description	Specifications	Picture	Weight	Customs Tariff No.	C/O*	SL*	WL.*	SNo.*	Stock*	WPC*	POH*	PU*	Sales price in \$
1895	Telescopic slides for the accessories container	<ul style="list-style-type: none"> – including mounting material – PU 2 pieces 		0.746 lb	84799070	MX	S			-		-	1 PU	98.00
1879	Tension spring for the B-axis	including mounting material		0.100 lb	85011091	DE	S			1		-	1 PCS	32.00
1878	Tool changer cover	<ul style="list-style-type: none"> – including mounting material – for use in machines with serial numbers starting with K5ID2 		0.050 lb	84799070	DE	U			1		-	1 PCS	43.00

* PU = packing unit | C/O = country of origin | SL = service level (U=user, S=service | WL = warranty limitation | SNo. = serial number required | Stock = stock recommendation

* WPC = wear parts and consumables | POH = parts on hand (recommended minimum quantity for on site service calls)

Price List: Spare Parts K5+

Pneumatical Parts

Art. No.	Description	Specifications	Picture	Weight	Customs Tariff No.	C/O*	SL*	WL.*	SNo.*	Stock*	WPC*	POH*	PU*	Sales price in \$
30333	Compressed air sensor	<i>for use in the following machines: K5 + K5 with control unit serial no. from 28960 K5 X with control unit serial no. from 26050</i>		0.108 lb	84799070	DE	S			-		-	1 PCS	230.00
1888	Dust protection vacuum sensor			0.011 lb	84799070	DE	S			2		-	1 PCS	30.00
1825	Filter element for service unit MICRO	date of manufacture of the machine from 04/2014		0.004 lb	84219990	HU	U			5	X	2	1 PCS	9.00
1922	Plastic hose 4 mm	- UL-94-certified - PU 3 m		1.587 ozm	84799070	CZ	S			-		-	1 PU	15.20

* PU = packing unit | C/O = country of origin | SL = service level (U=user, S=service | WL = warranty limitation | SNo. = serial number required | Stock = stock recommendation

* WPC = wear parts and consumables | POH = parts on hand (recommended minimum quantity for on site service calls)

Price List: Spare Parts K5+

Pneumatical Parts





Art. No.	Description	Specifications	Picture	Weight	Customs Tariff No.	C/O*	SL*	WL.*	SNo.*	Stock*	WPC*	POH*	PU*	Sales price in \$
1666	Service unit MICRO	with water separator, manometer and pressure regulator		0.500 lb	84811005	DE	U			1		-	1 PCS	159.00
1499	Solenoid valve MHP1-UL	for mounting at valve terminal, including – 2 screws – hose connector and plug-in connection wire – for UL certified machines – installed in S models since November 2013		0.816 lb	84812090	DE	S			1		-	1 PCS	74.00

* PU = packing unit | C/O = country of origin | SL = service level (U=user, S=service | WL = warranty limitation | SNo. = serial number required | Stock = stock recommendation

* WPC = wear parts and consumables | POH = parts on hand (recommended minimum quantity for on site service calls)

Price List: Spare Parts K5+

Miscellaneous



Art. No.	Description	Specifications	Picture	Weight	Customs Tariff No.	C/O*	SL*	WL.*	SNo.*	Stock*	WPC*	POH*	PU*	Sales price in \$
1725	Calibration blank 10 mm	<ul style="list-style-type: none"> – material PU – diameter 98 mm – thickness 10 mm 		0.500 lb	39211390	DE	U			1	X	3	1 PCS	7.50
30028	Carrying aid K5/K5+	including safety strap		11.365 lb	84799070	DE	U			-		-	1 PCS	242.00
1850	Fin Food Lube	<ul style="list-style-type: none"> – for linear guiding – PU 250 ml <i>safety data sheet: http://download.vhf.de</i>		0.500 lb	27101999	NL	S			1	X	1	1 PCS	64.00
1846	Flexible crevice nozzle			0.379 lb	84799070	MY	U			-		-	1 PCS	74.00

* PU = packing unit | C/O = country of origin | SL = service level (U=user, S=service | WL = warranty limitation | SNo. = serial number required | Stock = stock recommendation

* WPC = wear parts and consumables | POH = parts on hand (recommended minimum quantity for on site service calls)

Price List: Spare Parts K5+

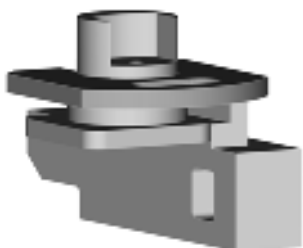
Miscellaneous

Art. No.	Description	Specifications	Picture	Weight	Customs Tariff No.	C/O*	SL*	WL.*	SNo.*	Stock*	WPC*	POH*	PU*	Sales price in \$
30059	M5 thread insert with assembling aid			0.010 lb	84799070	DE	S			10		-	1 PCS	6.50
2019	Transport lock K5	for spindle SFK 300P		0.220 lb	39239000	DE	U			1		-	1 PCS	41.00
1865	White Grease	– for ball screw spindles – tube 150 ml <i>safety data sheet: http://download.vhf.de</i>		0.500 lb	27101999	NL	U			1	X	-	1 PCS	63.00

* PU = packing unit | C/O = country of origin | SL = service level (U=user, S=service | WL = warranty limitation | SNo. = serial number required | Stock = stock recommendation

* WPC = wear parts and consumables | POH = parts on hand (recommended minimum quantity for on site service calls)

Price List: Spare Parts K5+
Spindles and Accessories

Art. No.	Description	Specifications	Picture	Weight	Customs Tariff No.	C/O*	SL*	WL.*	SNo.*	Stock*	WPC*	POH*	PU*	Sales price in \$
1728	Collet chuck 3 mm, rust-proof	packed separately		0.013 lb	84661020	DE	U			2	X	2	1 PCS	180.00
1760	High frequency spindle SFK 300P	– high frequency spindle rotational speed 5,000 to 60,000 RPM maximum power output 500 W continuous power 300 4-fold bearing hybrid ceramic ball bearings stainless steel collet chuck including service set <i>version with sealing air and cone cleaning including pneumatical collet chuck</i>		2.300 lb	84799070	DE	S		X	1	X	1	1 PCS	4,450.00
1730	Spindle service set	for collet chuck maintenance		0.132 lb	96039099	DE	U			1	X	1	1 PCS	57.00

* PU = packing unit | C/O = country of origin | SL = service level (U=user, S=service | WL = warranty limitation | SNo. = serial number required | Stock = stock recommendation
 * WPC = wear parts and consumables | POH = parts on hand (recommended minimum quantity for on site service calls)

Price List: Spare Parts K5+

Tools

Art. No.	Description	Specifications	Picture	Weight	Customs Tariff No.	C/O*	SL*	WL.*	SNo.*	Stock*	WPC*	POH*	PU*	Sales price in \$
1512	Dial indicator with stand	<ul style="list-style-type: none"> - with 3D articulated arm and clamp stand - for true running and axis backlash measurements - measuring accuracy ± 0.01 mm 		2.000 lb	84799070	JP	S			-		1	1 PCS	639.00
1841	Digital measuring slide	measuring range 100 mm		0.450 lb	84799070	CN	U			-		-	1 PCS	103.00
1655	Digital micrometer screw gauge	0–25 mm		1.000 lb	84799070	CN	U			1		-	1 PCS	180.00
1731	Drill with 3 mm shank	<ul style="list-style-type: none"> Ø cutting edge 2.80 mm, Ø shank 3.0 mm L cutting edge 10.5 mm, L total 38 mm with stop ring 		0.070 lb	82075090	DE	U			2	X	1	1 PCS	7.40

* PU = packing unit | C/O = country of origin | SL = service level (U=user, S=service | WL = warranty limitation | SNo. = serial number required | Stock = stock recommendation

* WPC = wear parts and consumables | POH = parts on hand (recommended minimum quantity for on site service calls)

Price List: Spare Parts K5+

Tools

Art. No.	Description	Specifications	Picture	Weight	Customs Tariff No.	C/O*	SL*	WL.*	SNo.*	Stock*	WPC*	POH*	PU*	Sales price in \$
1824	Service trolley case	<ul style="list-style-type: none"> - robust trolley case for service works - precise measuring equipment and high-quality tools - complete kit for all vhf Impression machines 		33.100 lb	82059090	DE	S			-		1	1 PCS	3,930.00

Please note that single articles can be used in several machine models. Our stock recommendation is intended for 1 to 20 machines per service base. We grant the standard discount for spare parts.

Warranty limitation: warranty claims can only be made if the relevant machine is inspected and repaired by vhf. Alternatively, the partner can order the part within the warranty period and exchange it at his/her own expense and liability.

Prices are list prices and do not include any discounts, tax, shipping or other charges that may apply • All purchases are subject to our Terms of Sale which can be found at www.vhf.com • Products, prices and terms are subject to change without notice • All product names, brands and trademarks are property of their respective owners • All prices exclude VAT, customs duties and transportation/packaging fees • All information given may change without further notice.