





## Price List: Spare Parts R5

### Electrical Parts





Art. No.	Description	Specifications	Picture	Weight	Customs Tariff No.	C/O*	SL*	WL.*	SNo.*	Stock*	WPC*	POH*	PU*	Sales price in \$
30120	A-axis cable	including A-axis board		0.209 lb	84799070	DE	S			-		-	1 PCS	232.00
1985	Assembly webcam working chamber	incl. USB cable and mounting material		0.364 lb	84799070	DE	S			-		-	1 PCS	504.00
30121	B-axis cable	including B-axis board		0.209 lb	84799070	DE	S			-		-	1 PCS	243.00
30123	Cable set (X, Y, R)	consisting of - axis cables (X, Y) - cable blank changer (R) - control unit connector		0.298 lb	84799070	DE	S			-		-	1 PCS	590.00

\* PU = packing unit | C/O = country of origin | SL = service level (U=user, S=service | WL = warranty limitation | SNo. = serial number required | Stock = stock recommendation

\* WPC = wear parts and consumables | POH = parts on hand (recommended minimum quantity for on site service calls)

## Price List: Spare Parts R5

### Electrical Parts

Art. No.	Description	Specifications	Picture	Weight	Customs Tariff No.	C/O*	SL*	WL.*	SNo.*	Stock*	WPC*	POH*	PU*	Sales price in \$
30108	Control unit R5			5.512 lb	85439000	DE	S		X	1		-	1 PCS	7,860.00
2052	Data cable Renfert SILENT CAM	- plug with 6 pins - length 5 m		0.364 lb	85087000	DE	U			-		-	1 PCS	74.00
30287	End switch B-axis	including mounting material		0.049 lb	85365019	CZ	S			-		-	1 PCS	59.00
30207	End switch X-axis	including mounting material		0.051 lb	85365019	CZ	S			1		-	1 PCS	59.00

\* PU = packing unit | C/O = country of origin | SL = service level (U=user, S=service | WL = warranty limitation | SNo. = serial number required | Stock = stock recommendation

\* WPC = wear parts and consumables | POH = parts on hand (recommended minimum quantity for on site service calls)

## Price List: Spare Parts R5

### Electrical Parts



Art. No.	Description	Specifications	Picture	Weight	Customs Tariff No.	C/O*	SL*	WL.*	SNo.*	Stock*	WPC*	POH*	PU*	Sales price in \$
30208	End switch Y-axis	including mounting material		0.051 lb	85365019	CZ	S			1		-	1 PCS	79.00
30209	End switch Z-axis	including mounting material		0.035 lb	85365019	CZ	S			1		-	1 PCS	59.00
2010	Ethernet cable	length approx. 2.0 m		0.174 lb	85444210	CN	U			1		-	1 PCS	12.30
30288	Ethernet socket	including mounting material		0.057 lb	84799070	GB	S			-		-	1 PCS	41.00

\* PU = packing unit | C/O = country of origin | SL = service level (U=user, S=service | WL = warranty limitation | SNo. = serial number required | Stock = stock recommendation

\* WPC = wear parts and consumables | POH = parts on hand (recommended minimum quantity for on site service calls)

## Price List: Spare Parts R5

### Electrical Parts



Art. No.	Description	Specifications	Picture	Weight	Customs Tariff No.	C/O*	SL*	WL.*	SNo.*	Stock*	WPC*	POH*	PU*	Sales price in \$
30367	Flow sensor	<ul style="list-style-type: none"> <li>– sensor without moving parts</li> <li>– including mounting material and hose connectors</li> </ul>		0.772 lb	90261021	FR	S			1		-	1 PCS	639.00
30181	Glass fuse T8.0A L250V	PU 10 pieces		0.035 lb	84799070	DE	S			1		1	1 PU	20.20
30289	Ion jet left			0.530 lb	84799070	DE	S			-		-	1 PCS	737.00
30290	Ion jet right			0.530 lb	84799070	DE	S			-		-	1 PCS	737.00

\* PU = packing unit | C/O = country of origin | SL = service level (U=user, S=service | WL = warranty limitation | SNo. = serial number required | Stock = stock recommendation

\* WPC = wear parts and consumables | POH = parts on hand (recommended minimum quantity for on site service calls)

### Price List: Spare Parts R5

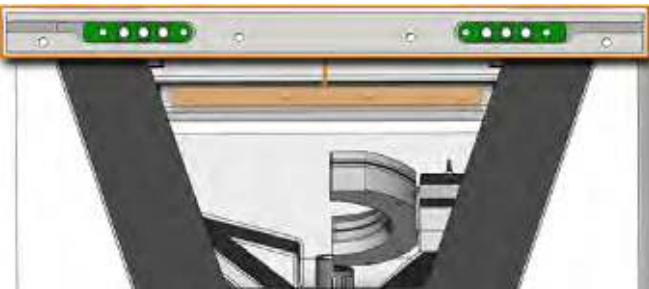
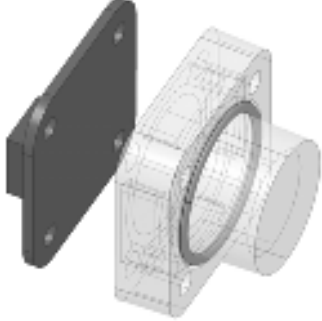
#### Electrical Parts



Art. No.	Description	Specifications	Picture	Weight	Customs Tariff No.	C/O*	SL*	WL.*	SNo.*	Stock*	WPC*	POH*	PU*	Sales price in \$
2008	LED Multi-purpose compartment lighting			0.099 lb	84799070	DE	S			1		-	1 PCS	128.00
2007	LED working chamber lighting			0.198 lb	84799070	DE	S			1		-	1 PCS	202.00
30291	LED working chamber lighting left			0.068 lb	84799070	DE	S			1		-	1 PCS	143.00
30293	Lower Hall sensor	including mounting material		0.500 lb	84799070	DE	S			-		-	1 PCS	107.00

\* PU = packing unit | C/O = country of origin | SL = service level (U=user, S=service | WL = warranty limitation | SNo. = serial number required | Stock = stock recommendation

\* WPC = wear parts and consumables | POH = parts on hand (recommended minimum quantity for on site service calls)

## Price List: Spare Parts R5

### Electrical Parts



Art. No.	Description	Specifications	Picture	Weight	Customs Tariff No.	C/O*	SL*	WL.*	SNo.*	Stock*	WPC*	POH*	PU*	Sales price in \$
30106B	Measuring key	<i>For use in machines where the serial number begins with R5ID5 and for machines with retrofitted plug in the A-axis assembly.</i>		1.000 lb	85365019	DE	S			1		1	1 PCS	639.00
30106	Measuring key upgrade kit	<i>For use in machines where the serial number begins with R5ID2, R5ID3 and R5ID4 as long as the A-axis assembly has not been retrofitted with a plug.</i>		0.500 lb	85365019	DE	S			1		1	1 PCS	639.00
1589	Power supply cord B	<ul style="list-style-type: none"> <li>- connector plug up to 120 V</li> <li>- plug type B</li> <li>- length approx. 1.8 m</li> <li>- UL certified</li> </ul>		0.700 lb	85444290		U			1		-	1 PCS	14.00
2018	Sensor pneumatic cylinder	including cable		0.220 lb	84799070	BG	S			-		-	1 PCS	128.00

\* PU = packing unit | C/O = country of origin | SL = service level (U=user, S=service | WL = warranty limitation | SNo. = serial number required | Stock = stock recommendation

\* WPC = wear parts and consumables | POH = parts on hand (recommended minimum quantity for on site service calls)

### Price List: Spare Parts R5

#### Electrical Parts

Art. No.	Description	Specifications	Picture	Weight	Customs Tariff No.	C/O*	SL*	WL.*	SNo.*	Stock*	WPC*	POH*	PU*	Sales price in \$
30107	Spindle cable			0.298 lb	85444290	DE	S			-		-	1 PCS	336.00
30292	Upper Hall sensor	including mounting material		0.093 lb	84799070	DE	S			-		-	1 PCS	104.00
30122	Z-axis cable	including Z-axis board		0.209 lb	84799070	DE	S			-		-	1 PCS	243.00



\* PU = packing unit | C/O = country of origin | SL = service level (U=user, S=service | WL = warranty limitation | SNo. = serial number required | Stock = stock recommendation

\* WPC = wear parts and consumables | POH = parts on hand (recommended minimum quantity for on site service calls)

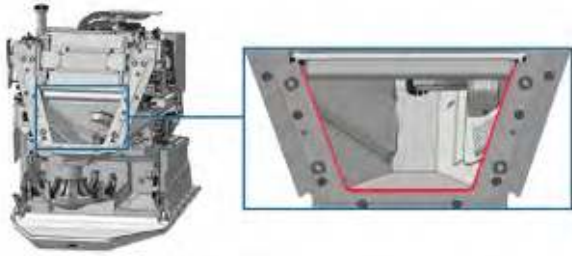

## Price List: Spare Parts R5

### Housings and Accessories

Art. No.	Description	Specifications	Picture	Weight	Customs Tariff No.	C/O*	SL*	WL.*	SNo.*	Stock*	WPC*	POH*	PU*	Sales price in \$
30210	Gasket profile working chamber door	<ul style="list-style-type: none"> <li>– Gasket for working chamber</li> <li>– 1,000 mm</li> <li><i>For machines with groove on the lower part of the lifting unit ≤ R5ID6.</i></li> </ul>		0.110 lb	40169300	DE	S			1	X	1	1 PCS	40.00
30345	Gasket working chamber door	<ul style="list-style-type: none"> <li>– Gasket for working chamber</li> <li>– self-adhesive</li> <li>– 1,000 mm</li> <li><i>For machines without groove on the lower part of the lifting unit.</i></li> </ul>		0.022 lb	84799070	DE	S			1		1	1 PCS	10.00
30294	Housing cover R5, type vhf	<ul style="list-style-type: none"> <li>– with vhf labelling, colour signal white (RAL 9003)</li> <li>– including housing screws</li> <li>– without identification label</li> </ul>		44.092 lb	84799070	DE	S			-		-	1 PCS	4,030.00
2001	Multi-purpose compartment flap, type vhf	<ul style="list-style-type: none"> <li>– including mounting material</li> <li>– with labeling "vhf"</li> </ul>		3.307 lb	84799070	DE	S			-		-	1 PCS	641.00



\* PU = packing unit | C/O = country of origin | SL = service level (U=user, S=service | WL = warranty limitation | SNo. = serial number required | Stock = stock recommendation

\* WPC = wear parts and consumables | POH = parts on hand (recommended minimum quantity for on site service calls)



## Price List: Spare Parts R5

### Housings and Accessories

Art. No.	Description	Specifications	Picture	Weight	Customs Tariff No.	C/O*	SL*	WL.*	SNo.*	Stock*	WPC*	POH*	PU*	Sales price in \$
30109	Sealing cord multi-purpose compartment flap			0.033 lb	40169300		S			1		1	1 PCS	19.60
2004	Spring multi-purpose compartment flap	– including mounting material – PU 2 pieces		0.176 lb	84799070	DE	S			-		-	1 PU	34.00
1994	Working chamber door	– including mounting material <i>For use in machines where the serial number begins with R5ID1 or R5ID2 where the working chamber door has not been retrofitted.</i>		9.700 lb	84799070	DE	S			-		-	1 PCS	1,610.00
1994B	Working chamber door	– including mounting material <i>For use in machines with the serial number from R5ID3 and for machines with retrofitted working chamber door.</i>		9.260 lb	84799070	DE	S			-		-	1 PCS	1,610.00

\* PU = packing unit | C/O = country of origin | SL = service level (U=user, S=service | WL = warranty limitation | SNo. = serial number required | Stock = stock recommendation

\* WPC = wear parts and consumables | POH = parts on hand (recommended minimum quantity for on site service calls)

### Price List: Spare Parts R5

#### Mechanical Parts

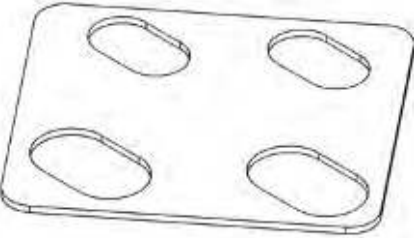

Art. No.	Description	Specifications	Picture	Weight	Customs Tariff No.	C/O*	SL*	WL.*	SNo.*	Stock*	WPC*	POH*	PU*	Sales price in \$
30343	Anti-rotation lock blank holder	PU 2 pieces		0.013 lb	84799070	DE	S			2		2	1 PU	19.60
30302	Ball screw drive X-axis	including mounting material		0.000 lb	84799070	DE	S	X		-		-	1 PCS	1,380.00
30303	Ball screw drive Y-axis	including mounting material		0.000 lb	84799070	DE	S	X		-		-	1 PCS	1,430.00
30304	Ball screw drive Z-axis	– including mounting material for use in machines with serial numbers ≤ R5/D6		0.000 lb	84799070	DE	S	X		-		-	1 PCS	1,280.00

\* PU = packing unit | C/O = country of origin | SL = service level (U=user, S=service | WL = warranty limitation | SNo. = serial number required | Stock = stock recommendation

\* WPC = wear parts and consumables | POH = parts on hand (recommended minimum quantity for on site service calls)

## Price List: Spare Parts R5

### Mechanical Parts

Art. No.	Description	Specifications	Picture	Weight	Customs Tariff No.	C/O*	SL*	WL.*	SNo.*	Stock*	WPC*	POH*	PU*	Sales price in \$
30304B	Ball screw drive Z-axis	– including mounting material for use in machines with serial numbers ≥ R5ID7		0.000 lb	84799070	DE	S	X		-		-	1 PCS	1,430.00
1661	Bellows coupling	including screws		0.022 lb	84799070	DE	S			1		-	1 PCS	67.00
1986	Bellows spindle	including mounting material		0.364 lb	84799070	DE	S			1		-	1 PCS	434.00
30228	Blank carrier			0.320 lb	84799070	DE	S			-		-	1 PCS	294.00

\* PU = packing unit | C/O = country of origin | SL = service level (U=user, S=service | WL = warranty limitation | SNo. = serial number required | Stock = stock recommendation

\* WPC = wear parts and consumables | POH = parts on hand (recommended minimum quantity for on site service calls)

### Price List: Spare Parts R5

#### Mechanical Parts



Art. No.	Description	Specifications	Picture	Weight	Customs Tariff No.	C/O*	SL*	WL.*	SNo.*	Stock*	WPC*	POH*	PU*	Sales price in \$
30551	Blank changing unit assembly	– including mounting material <i>can be used for machines with serial numbers ≥ R5ID5</i>		1.753 lb	84799070	DE	S			-		-	1 PCS	1,020.00
1997	Blank holder	including mounting material		1.224 lb	84799070	DE	S			1		-	1 PCS	1,610.00
30562	Blank holder gasket			0.000 lb	84799070	DE	U			1		1	1 PCS	53.00
30387	Carriage cover	including mounting material		0.000 lb	84799070	DE	S			-		-	1 PCS	319.00

\* PU = packing unit | C/O = country of origin | SL = service level (U=user, S=service | WL = warranty limitation | SNo. = serial number required | Stock = stock recommendation

\* WPC = wear parts and consumables | POH = parts on hand (recommended minimum quantity for on site service calls)

## Price List: Spare Parts R5

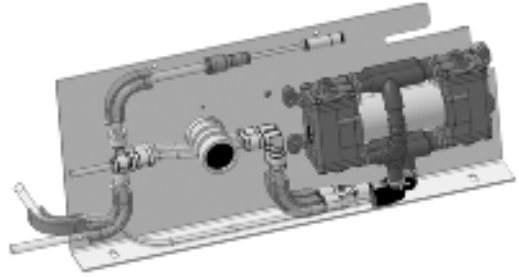
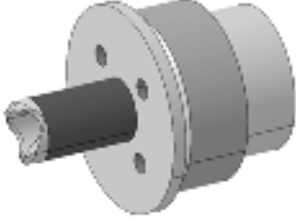
### Mechanical Parts

Art. No.	Description	Specifications	Picture	Weight	Customs Tariff No.	C/O*	SL*	WL.*	SNo.*	Stock*	WPC*	POH*	PU*	Sales price in \$
1943	Cooling liquid pump	including mounting material and hose connectors <b>R5: can be used for machines with serial numbers <math>\geq R5ID6</math> and retrofitted machines with serial numbers <math>\leq R5ID5</math></b>		2.180 lb	84799070	DE	S			1	X	1	1 PCS	798.00
1984	Cooling liquid pump assembly	including mounting material		5.401 lb	84799070	DE	S			1		-	1 PCS	1,520.00
30313	Coupler plug			0.375 lb	84799070	DE	S			-		-	1 PCS	123.00
30305	Fan working chamber	including mounting material and seals		0.170 lb	84799070	DE	S			1		-	1 PCS	121.00

\* PU = packing unit | C/O = country of origin | SL = service level (U=user, S=service | WL = warranty limitation | SNo. = serial number required | Stock = stock recommendation

\* WPC = wear parts and consumables | POH = parts on hand (recommended minimum quantity for on site service calls)

### Price List: Spare Parts R5

#### Mechanical Parts



Art. No.	Description	Specifications	Picture	Weight	Customs Tariff No.	C/O*	SL*	WL.*	SNo.*	Stock*	WPC*	POH*	PU*	Sales price in \$
1987	Folding bellow X-axis	set consisting of 2 pieces		0.420 lb	84799070	DE	S			1		1	1 PU	403.00
1803	Harmonic drive	including harmonic drive grease		0.441 lb	84834090	DE	S	X		-		-	1 PCS	2,950.00
30295	Motor A-axis	including mounting material		0.882 lb	85011091	CN	S			-		-	1 PCS	216.00
30296	Motor B-axis	including bolts and mounting material		0.904 lb	85011091	CN	S			-		-	1 PCS	216.00

\* PU = packing unit | C/O = country of origin | SL = service level (U=user, S=service | WL = warranty limitation | SNo. = serial number required | Stock = stock recommendation

\* WPC = wear parts and consumables | POH = parts on hand (recommended minimum quantity for on site service calls)

### Price List: Spare Parts R5

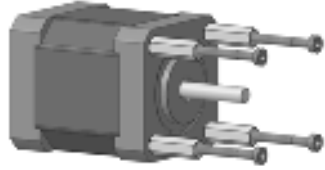
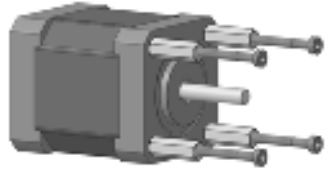
#### Mechanical Parts

Art. No.	Description	Specifications	Picture	Weight	Customs Tariff No.	C/O*	SL*	WL.*	SNo.*	Stock*	WPC*	POH*	PU*	Sales price in \$
30585	Motor working chamber door lifting unit	including mounting material		1.504 lb	84799070	DE	S			-		-	1 PCS	468.00
30297	Motor X-axis	including bolts and mounting material		0.882 lb	85011091	CN	S			-		-	1 PCS	216.00
30298	Motor Y-axis	including bolts and mounting material		0.904 lb	85011091	CN	S			-		-	1 PCS	216.00
30299	Motor Z-axis	including bolts and mounting material		1.235 lb	85011091	CN	S			-		-	1 PCS	475.00

\* PU = packing unit | C/O = country of origin | SL = service level (U=user, S=service | WL = warranty limitation | SNo. = serial number required | Stock = stock recommendation

\* WPC = wear parts and consumables | POH = parts on hand (recommended minimum quantity for on site service calls)



## Price List: Spare Parts R5

### Mechanical Parts

Art. No.	Description	Specifications	Picture	Weight	Customs Tariff No.	C/O*	SL*	WL.*	SNo.*	Stock*	WPC*	POH*	PU*	Sales price in \$
30300	Nozzle cover	– including mounting material <i>For use in machines with the serial number up to R5ID5</i>		0.088 lb	84799070	DE	S			1		1	1 PCS	237.00
2002	Power spring working chamber door			2.160 lb	84799070	DE	S			-		-	1 PCS	515.00
30366	Rubber gasket for ion jet	including mounting material		0.033 lb	84799070	DE	S			-		-	1 PCS	16.10
1988	Slat cover Y-axis assembly	including mounting material		3.527 lb	84799070	DE	S			1		-	1 PCS	1,700.00

\* PU = packing unit | C/O = country of origin | SL = service level (U=user, S=service | WL = warranty limitation | SNo. = serial number required | Stock = stock recommendation

\* WPC = wear parts and consumables | POH = parts on hand (recommended minimum quantity for on site service calls)

## Price List: Spare Parts R5

### Mechanical Parts

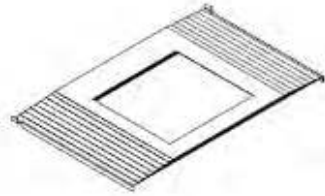
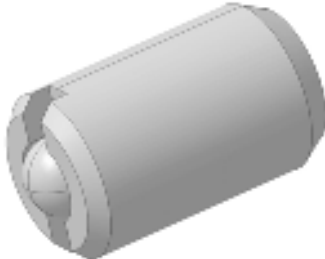
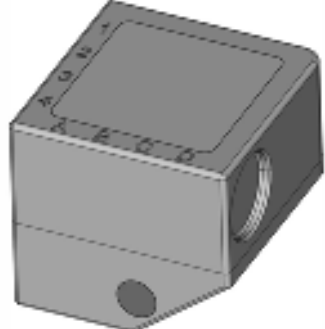
Art. No.	Description	Specifications	Picture	Weight	Customs Tariff No.	C/O*	SL*	WL.*	SNo.*	Stock*	WPC*	POH*	PU*	Sales price in \$
30211	Slat set Y-axis	<ul style="list-style-type: none"> <li>- 9 slats</li> <li>- including mounting material</li> </ul>		1.543 lb	84799070	DE	S			1		-	1 PCS	672.00
30301	Spring plunger cooling liquid tank			0.088 lb	84799070		S			-		-	1 PCS	46.00
30560	Spring plunger tool magazine	to be glued with Loctite 243		0.000 lb	84799070	CN	S			-		-	1 PCS	22.60
1998	Tool magazine	including tool magazine insert		0.287 lb	84799070	DE	U			-		-	1 PCS	324.00

\* PU = packing unit | C/O = country of origin | SL = service level (U=user, S=service | WL = warranty limitation | SNo. = serial number required | Stock = stock recommendation

\* WPC = wear parts and consumables | POH = parts on hand (recommended minimum quantity for on site service calls)

## Price List: Spare Parts R5

### Mechanical Parts

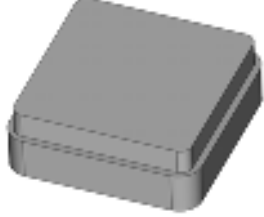
Art. No.	Description	Specifications	Picture	Weight	Customs Tariff No.	C/O*	SL*	WL.*	SNo.*	Stock*	WPC*	POH*	PU*	Sales price in \$
1999	Tool magazine insert	PU 5 pieces		0.121 lb	84799070	DE	U			2	X	1	1 PU	62.00

\* PU = packing unit | C/O = country of origin | SL = service level (U=user, S=service | WL = warranty limitation | SNo. = serial number required | Stock = stock recommendation

\* WPC = wear parts and consumables | POH = parts on hand (recommended minimum quantity for on site service calls)

## Price List: Spare Parts R5

### Pneumatical Parts





Art. No.	Description	Specifications	Picture	Weight	Customs Tariff No.	C/O*	SL*	WL.*	SNo.*	Stock*	WPC*	POH*	PU*	Sales price in \$
2006	Compressed air regulator	<i>for use in machines where the serial number begins with R5ID2</i>		0.474 lb	84811005	HU	S			1		-	1 PCS	160.00
30307	Compressed air regulator	<i>for use in machines with the serial number from R5ID3</i>		0.584 lb	84811005	HU	S			1		-	1 PCS	176.00
30306	Compressed air sensor	including pneumatic hose and connection cable with connector		0.000 lb	84799070	DE	S			1		-	1 PCS	226.00
1825	Filter element for service unit MICRO	date of manufacture of the machine from 04/2014		0.004 lb	84219990	HU	U			5	X	2	1 PCS	9.00

\* PU = packing unit | C/O = country of origin | SL = service level (U=user, S=service | WL = warranty limitation | SNo. = serial number required | Stock = stock recommendation

\* WPC = wear parts and consumables | POH = parts on hand (recommended minimum quantity for on site service calls)

## Price List: Spare Parts R5

### Pneumatical Parts

Art. No.	Description	Specifications	Picture	Weight	Customs Tariff No.	C/O*	SL*	WL.*	SNo.*	Stock*	WPC*	POH*	PU*	Sales price in \$
1664	Plastic hose 6 mm	<ul style="list-style-type: none"> <li>- UL-94-certified</li> <li>- 10 bar max.</li> <li>- PU 3 m</li> </ul>		0.015 lb	39173200	DE	U			1		-	1 PU	15.20
2041	Pneumatic connector (straight)			0.018 lb	84799070	TW	S			-		-	1 PCS	8.70
2013	Pneumatic cylinder for multi-purpose compartment flap, assembly			0.290 lb	84799070	DE	S			-		-	1 PCS	154.00
1499	Solenoid valve MHP1-UL	<ul style="list-style-type: none"> <li>for mounting at valve terminal, including</li> <li>- 2 screws</li> <li>- hose connector and plug-in connection wire</li> <li>- for UL certified machines</li> <li>- installed in S models since November 2013</li> </ul>		0.816 lb	84812090	DE	S			1		-	1 PCS	74.00

\* PU = packing unit | C/O = country of origin | SL = service level (U=user, S=service | WL = warranty limitation | SNo. = serial number required | Stock = stock recommendation

\* WPC = wear parts and consumables | POH = parts on hand (recommended minimum quantity for on site service calls)

### Price List: Spare Parts R5

#### Pneumtical Parts

Art. No.	Description	Specifications	Picture	Weight	Customs Tariff No.	C/O*	SL*	WL.*	SNo.*	Stock*	WPC*	POH*	PU*	Sales price in \$
2012	Swivel cylinder workpiece changer			0.364 lb	84799070	DE	S			-		-	1 PCS	312.00

\* PU = packing unit | C/O = country of origin | SL = service level (U=user, S=service | WL = warranty limitation | SNo. = serial number required | Stock = stock recommendation

\* WPC = wear parts and consumables | POH = parts on hand (recommended minimum quantity for on site service calls)

## Price List: Spare Parts R5

### Miscellaneous

Art. No.	Description	Specifications	Picture	Weight	Customs Tariff No.	C/O*	SL*	WL.*	SNo.*	Stock*	WPC*	POH*	PU*	Sales price in \$
30558	Blank holder gasket			0.000 lb	84799070	DE	U			1		1	1 PCS	52.00
2063	Block holder set	<ul style="list-style-type: none"> <li>– to hold 6 grinding blocks with round mandrel</li> <li>– including torque wrench 1.8 Nm and case</li> </ul>		1.323 lb	84799070	DE	U			1		-	1 PCS	394.00
1725	Calibration blank 10 mm	<ul style="list-style-type: none"> <li>– material PU</li> <li>– diameter 98 mm</li> <li>– thickness 10 mm</li> </ul>		0.500 lb	39211390	DE	U			1	X	3	1 PCS	7.50
2061	Cleaning brush	PU 5 pieces		0.408 lb	96039099		U			1		-	1 PU	24.60



\* PU = packing unit | C/O = country of origin | SL = service level (U=user, S=service | WL = warranty limitation | SNo. = serial number required | Stock = stock recommendation

\* WPC = wear parts and consumables | POH = parts on hand (recommended minimum quantity for on site service calls)

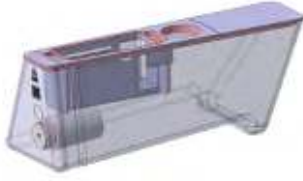

### Price List: Spare Parts R5

#### Miscellaneous



Art. No.	Description	Specifications	Picture	Weight	Customs Tariff No.	C/O*	SL*	WL.*	SNo.*	Stock*	WPC*	POH*	PU*	Sales price in \$
30206	Cooling liquid sponge	PU 5 pieces		0.011 lb	84799070	DE	U			2	X	1	1 PU	16.10
1989	Cooling liquid tank assembly	including coupling and cooling liquid filter		3.000 lb	84799070	DE	U			1		-	1 PCS	733.00
1991	Cooling liquid tank coupling	including gasket		0.044 lb	84799070	DE	U			1		1	1 PCS	98.00
30310	Cooling liquid tank cover	<i>for use in machines where the serial number begins with R5ID3</i>		0.452 lb	84799070	DE	U			1		-	1 PCS	128.00

\* PU = packing unit | C/O = country of origin | SL = service level (U=user, S=service | WL = warranty limitation | SNo. = serial number required | Stock = stock recommendation

\* WPC = wear parts and consumables | POH = parts on hand (recommended minimum quantity for on site service calls)

## Price List: Spare Parts R5

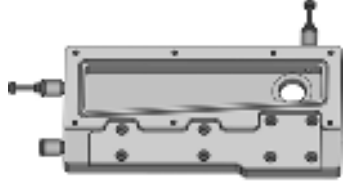
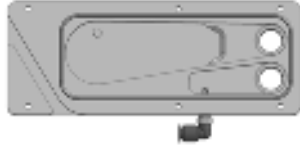
### Miscellaneous



Art. No.	Description	Specifications	Picture	Weight	Customs Tariff No.	C/O*	SL*	WL.*	SNo.*	Stock*	WPC*	POH*	PU*	Sales price in \$
30214	Drainage channel for cooling liquid, assembly	<i>for use in machines with the serial number up to R5ID3</i>		0.794 lb	84799070	DE	S			1		1	1 PCS	393.00
30214B	Drainage channel for cooling liquid, assembly	<i>for use in machines where the serial number begins with R5ID4</i>		0.754 lb	84799070	DE	S			1		1	1 PCS	393.00
30308	Filter for cooling liquid tank	for installation in the cooling liquid filter – including fine filter and activated carbon pellets		0.176 lb	84799070	DE	U			1		1	1 PCS	195.00
30309	Filter set	consisting of – 3 pcs. of fine filter – 6 g of activated carbon pellets		0.500 lb	84212100	DE	U			5	X	1	1 SET	23.70

\* PU = packing unit | C/O = country of origin | SL = service level (U=user, S=service | WL = warranty limitation | SNo. = serial number required | Stock = stock recommendation

\* WPC = wear parts and consumables | POH = parts on hand (recommended minimum quantity for on site service calls)

## Price List: Spare Parts R5

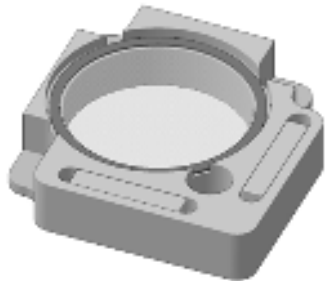
### Miscellaneous



Art. No.	Description	Specifications	Picture	Weight	Customs Tariff No.	C/O*	SL*	WL.*	SNo.*	Stock*	WPC*	POH*	PU*	Sales price in \$
30509	Filter working chamber ventilation			0.088 lb	84799070	DE	U			-		-	1 PCS	76.00
1850	Fin Food Lube	<ul style="list-style-type: none"> <li>- for linear guiding</li> <li>- PU 250 ml</li> <li><i>safety data sheet: <a href="http://download.vhf.de">http://download.vhf.de</a></i></li> </ul>		0.500 lb	27101999	NL	S			1	X	1	1 PCS	64.00
1846	Flexible crevice nozzle			0.379 lb	84799070	MY	U			-		-	1 PCS	74.00
1923	Grub screw M5x10 A2	PU 3 pieces		0.044 lb	73181535	DE	U			1	X	1	1 PU	5.30

\* PU = packing unit | C/O = country of origin | SL = service level (U=user, S=service | WL = warranty limitation | SNo. = serial number required | Stock = stock recommendation

\* WPC = wear parts and consumables | POH = parts on hand (recommended minimum quantity for on site service calls)

## Price List: Spare Parts R5

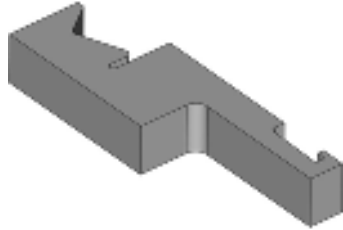
### Miscellaneous



Art. No.	Description	Specifications	Picture	Weight	Customs Tariff No.	C/O*	SL*	WL.*	SNo.*	Stock*	WPC*	POH*	PU*	Sales price in \$
1831	Interdental brush 0.6 mm blue	– including protective cap – PU 5 pieces		0.020 lb	84799070	DE	U			1		-	1 PU	11.10
30114	Mounting aid working chamber door			0.198 lb	84799070	DE	S			1		1	1 PCS	29.00
30113	Protective cap for the webcam			0.044 lb	84799070	DE	U			1		1	1 PCS	56.00
30557	Retrofit kit B-axis cable guide	including mounting material		0.500 lb	84799070	DE	S			1		1	1 PCS	48.00

\* PU = packing unit | C/O = country of origin | SL = service level (U=user, S=service | WL = warranty limitation | SNo. = serial number required | Stock = stock recommendation

\* WPC = wear parts and consumables | POH = parts on hand (recommended minimum quantity for on site service calls)

## Price List: Spare Parts R5

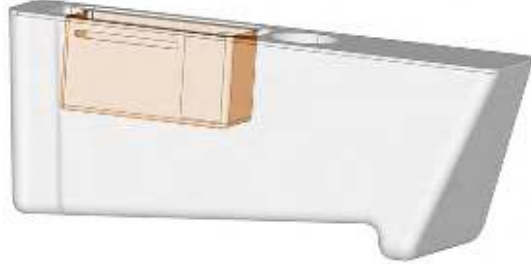
### Miscellaneous

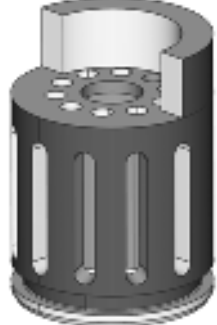

Art. No.	Description	Specifications	Picture	Weight	Customs Tariff No.	C/O*	SL*	WL.*	SNo.*	Stock*	WPC*	POH*	PU*	Sales price in \$
30110	Strainer basket	without cooling liquid tank		0.430 lb	84799070	DE	U			1		1	1 PCS	177.00
2014	Transport lock R5	for spindle SFR 400P		0.154 lb	39239000	DE	U			1		1	1 PCS	23.00
1865	White Grease	– for ball screw spindles – tube 150 ml <i>safety data sheet: <a href="http://download.vhf.de">http://download.vhf.de</a></i>		0.500 lb	27101999	NL	U			1	X	-	1 PCS	63.00
30215	Working chamber outlet cylinder			0.254 lb	84799070	DE	U			-		-	1 PCS	128.00

\* PU = packing unit | C/O = country of origin | SL = service level (U=user, S=service | WL = warranty limitation | SNo. = serial number required | Stock = stock recommendation

\* WPC = wear parts and consumables | POH = parts on hand (recommended minimum quantity for on site service calls)

### Price List: Spare Parts R5

#### Spindles and Accessories

Art. No.	Description	Specifications	Picture	Weight	Customs Tariff No.	C/O*	SL*	WL.*	SNo.*	Stock*	WPC*	POH*	PU*	Sales price in \$
30045	Collet chuck 3 mm, stainless	with ceramic coating		0.050 lb	84661020	DE	U			2	X	1	1 PCS	238.00
1919	High frequency spindle SFR 400P	– high frequency spindle rotational speed up to 80,000 RPM maximum power output 800 W continuous power 440 W 4-fold bearing hybrid ceramic ball bearings stainless steel collet chuck with ceramic coating including service set and mounting material <i>version with sealing air and cone cleaning including pneumatic collet chuck</i>		2.500 lb	84799070	DE	S		X	1		1	1 PCS	5,700.00
1730	Spindle service set	for collet chuck maintenance		0.132 lb	96039099	DE	U			1	X	1	1 PCS	57.00

\* PU = packing unit | C/O = country of origin | SL = service level (U=user, S=service | WL = warranty limitation | SNo. = serial number required | Stock = stock recommendation

\* WPC = wear parts and consumables | POH = parts on hand (recommended minimum quantity for on site service calls)

## Price List: Spare Parts R5

## Tools

Art. No.	Description	Specifications	Picture	Weight	Customs Tariff No.	C/O*	SL*	WL.*	SNo.*	Stock*	WPC*	POH*	PU*	Sales price in \$
1512	Dial indicator with stand	<ul style="list-style-type: none"> <li>- with 3D articulated arm and clamp stand</li> <li>- for true running and axis backlash measurements</li> <li>- measuring accuracy <math>\pm 0.01</math> mm</li> </ul>		2.000 lb	84799070	JP	S			-		1	1 PCS	639.00
1841	Digital measuring slide	measuring range 100 mm		0.450 lb	84799070	CN	U			-		-	1 PCS	103.00
1655	Digital micrometer screw gauge	0–25 mm		1.000 lb	84799070	CN	U			1		-	1 PCS	180.00
1731	Drill with 3 mm shank	<ul style="list-style-type: none"> <li>Ø cutting edge 2.80 mm, Ø shank 3.0 mm</li> <li>L cutting edge 10.5 mm, L total 38 mm</li> <li>with stop ring</li> </ul>		0.070 lb	82075090	DE	U			2	X	1	1 PCS	7.40





\* PU = packing unit | C/O = country of origin | SL = service level (U=user, S=service | WL = warranty limitation | SNo. = serial number required | Stock = stock recommendation

\* WPC = wear parts and consumables | POH = parts on hand (recommended minimum quantity for on site service calls)



## Price List: Spare Parts R5

### Tools

Art. No.	Description	Specifications	Picture	Weight	Customs Tariff No.	C/O*	SL*	WL.*	SNo.*	Stock*	WPC*	POH*	PU*	Sales price in \$
1652	Hexagon socket screwdriver 2.5 mm			0.077 lb	82054000	DE	U			1		-	1 PCS	11.40
2040	Insert bit 2.5x25 mm			0.018 lb	82042000	DE	U			-		-	1 PCS	8.00
1654	Measuring pin	for automatic measuring		0.009 lb	82075090	DE	U			10	X	2	1 PCS	8.20
1824	Service trolley case	<ul style="list-style-type: none"> <li>- robust trolley case for service works</li> <li>- precise measuring equipment and high-quality tools</li> <li>- complete kit for all vhf Impression machines</li> </ul>		33.100 lb	82059090	DE	S			-		1	1 PCS	3,930.00

\* PU = packing unit | C/O = country of origin | SL = service level (U=user, S=service | WL = warranty limitation | SNo. = serial number required | Stock = stock recommendation

\* WPC = wear parts and consumables | POH = parts on hand (recommended minimum quantity for on site service calls)

**Price List: Spare Parts R5**

**Tools**

Art. No.	Description	Specifications	Picture	Weight	Customs Tariff No.	C/O*	SL*	WL.*	SNo.*	Stock*	WPC*	POH*	PU*	Sales price in \$
1769	Torque wrench 1.8 Nm	without insert bit		0.143 lb	82041100	TW	U			-		-	1 PCS	24.60

Please note that single articles can be used in several machine models. Our stock recommendation is intended for 1 to 20 machines per service base. We grant the standard discount for spare parts.  
 Warranty limitation: warranty claims can only be made if the relevant machine is inspected and repaired by vhf. Alternatively, the partner can order the part within the warranty period and exchange it at his/her own expense and liability.

Prices are list prices and do not include any discounts, tax, shipping or other charges that may apply • All purchases are subject to our Terms of Sale which can be found at [www.vhf.com](http://www.vhf.com) • Products, prices and terms are subject to change without notice • All product names, brands and trademarks are property of their respective owners • All prices exclude VAT, customs duties and transportation/packaging fees • All information given may change without further notice.